

GIARNALDO®

Gefässe für Haus und Garten
Pots for home and garden

**PREIS
LISTE
2021**
LISTE DE PRIX



Giarnaldo GmbH
CH-4513 Langendorf

T 032 623 54 80
info@giarnaldo.ch
www.giarnaldo.ch

GIARNALDO

NEUHEITEN

2021



**QUADRO
ELEGANCE 40**
Seite 29



ZEUS MATT
Seite 30



**CASSETTA
ELEGANCE 80**
Seite 29



**TYLUS
ELEGANCE 30**
Seite 29

CALYPSO MATT
Seite 31



GIARNALDO



NEUHEIT



PET.POTS.LIFE



Pet bekommt ein neues Leben in Form eines Gefäßes.

4PUNKTE.EIGENSCHAFTEN.NEUHEIT

GRUNDMATERIAL.PET



RANDDICKE



HANDBEARBEITUNG



INDOOR/OUTDOOR



GIARNALDO

NOVAVITA



- 6 LEONARDO POT
- 7 LEONARDO TRAY
- 8 **NEU** TIZIANO
- 9 CARAVAGGIO CUBE
- 9 CARAVAGGIO PLANTER
- 10 MICHELANGELO WINDOW BOX
- 10 MICHELANGELO TRAY

MATT



- 11 LIGNUM
- 12 QUADRI
- 13 QUADRI 40 LONG
- 14 PENDULUM SQUARE
- 14 HANGING SYSTEM FÜR PENDULUM
- 15 PENDULUM LONG
- 16 OLLA 40
- 16 CITTA
- 17 MURUS 90
- 18 CYLINDRUS FP
- 18 SITZKISSEN CYLINDRUS
- 19 LINEA 40
- 19 LINEA 100
- 20 BASSO FP
- 20 TISCHPLATTE BASSO FP
- 20 OLLA TABLE HERBA
- 21 KRONOS
- 22 HERA
- 23 CLIO
- 23 THETIS
- 24 ATHENA
- 24 IRIS
- 25 ECHO
- 25 MYRIA
- 25 CHIRON
- 26 MOMUS
- 27 MINOS
- 27 MINOS CASSETTA
- 27 ARES
- 28 MODUS CASSETTA
- 29 **NEU** QUADRO ELEGANCE 40
- 29 **NEU** CASSETTA ELEGANCE 80
- 29 **NEU** TYLUS ELEGANCE 30

GLOSS



- 30 ZEUS GLOSS
- 30 **NEU** ZEUS MATT
- 31 CALYPSO GLOSS
- 31 **NEU** CALYPSO MATT
- 32 LOGOS GLOSS
- 32 TALOS GLOSS
- 32 TYLUS GLOSS

MOON LIGHT



- 33 MODULO CUBO MOONLIGHT
- 33 VASO MYMOU MOONLIGHT
- 33 VASO LULLABY MOONLIGHT
- 33 VASO MOD'O MOONLIGHT
- 33 VASO TONDO ALTO MOONLIGHT

NATURALIA



- 34 VASO CILINDRO NATURALIA
- 34 QUADRO NATURALIA
- 34 CASSETTA NATURALIA
- 34 SOTTOVASO NATURALIA

MOOD



- | | | | |
|----|-------------------|----|--------------------|
| 35 | MYMOOD RAIL | 37 | MYMOOD VASO |
| 35 | MYMOOD RAIL LONG | 37 | UNTERTELLER EXPORT |
| 36 | MYMOOD VASO TOWER | 37 | MYMOOD VASO ALTO |
| 36 | MYMOOD SCHALE | | |

DECOR MATT



- | | | | |
|----|-----------------------------|----|------------------------------|
| 38 | VASO DOPPIO BORDO FESTONATO | 41 | VASO QUADRO RIGATO |
| 38 | VASO MILO | 41 | CONCA TONDO RIGATO |
| 39 | VASO LISCIO TOSCANO | 41 | VASO TONDO RIGATO |
| 39 | VASO CONCA CORTEN | 42 | VASO TONDO LISCIO BORDATO |
| 40 | VASO RODI | 42 | VASO QUADRO LISCIO BORDATO |
| 40 | VASO QMR LINGOTTO | 42 | CASSETTA OVALE LISCIA |
| 40 | MAXI CASSETTA KEA | 43 | CASSETTA LISCIA |
| 40 | CASSETTA MR | 43 | VASO QUADRO LISCIO |
| 41 | VASO TERRANO LISCIO | 43 | CASSETTA ALTA 62 (EINWANDIG) |

DESIGN GEFÄSSE



- | | | | |
|----|--|----|--|
| 44 | VASO MODULO 40 (DOPPELWANDIG) | 45 | CASSETTA MOD'O (50 CM) |
| 44 | VASO MODULO 50 | 45 | VASO MOD'O (95 CM) |
| 44 | CASSETTA MODULO | 45 | VASO CONICO |
| 44 | CASSETTA ALTA MODULO 80 (DOPPELWANDIG) | 46 | VASO TONDO ALTO (70 CM & 100 CM & 120 CM) |
| 45 | VASO MODULO (NIEDER) | 46 | VASO QUADRO ALTO (70 CM & 100 CM & 120 CM) |
| 45 | VASO MOD'O (75 CM) | | |

HILLARY'S PAGANI



47-52 HILARY'S PAGANI GEFÄSSE

VERFÜGBARKEIT NUR AUF ANFRAGE | DISPONIBILITÉ SUR DEMANDE

UNTERTELLER









- | | | | |
|-------|-----------------------------|-------|------------------------------|
| 53 | ATLAS UNTERTELLER RUND | 56 | UNTERTELLER RECHTECKIG (CMR) |
| 53 | THEMIS SOTTOCASSETTA QUADRO | 57 | UNTERTELLER RECHTECKIG |
| 54 | THEMIS SOTTOCASSETTA | 57-58 | UNTERTELLER QUADRATISCH |
| 54 | ZUBEHÖR ACCESSOIRES | 58 | UNTERTELLER SAGOMATO |
| 55 | UNTERTELLER SVR | 58 | UNTERTELLER OVAL |
| 55 | UNTERTELLER SVM | | |
| 55-56 | UNTERTELLER RUND | | |

GEFÄSSE AUS 100% RECYCLIERTEM MATERIAL



LEONARDO POT

| CODE |  cm |  L |  ASO | CHF |  |  |  |  |
|---------|--|---|---|---------------|---|---|---|---|
| ATC.010 | 10 x 9.5 h. | 0.6 L | ASO.010 | 8.00 | A | G | CO | W |
| ATC.015 | 15 x 13 h. | 1.5 L | ASO.015 | 11.50 | A | G | CO | W |
| ATC.020 | 20 x 17.5 h. | 4 L | ASO.020 | 21.00 | A | G | CO | W |
| ATC.030 | 30 x 25 h. | 10 L | ASO.030 | 35.00 | A | G | CO | W |
| ATC.040 | 40 x 34 h. | 26 L | ASO.040 | 59.00 | A | G | CO | W |
| ATC.050 | 50 x 47 h. | 70 L | ASO.050 | 99.00 | A | G | CO | W |
| ATC.075 | 73 x 64.5 h. | 180 L | ASO.075 | 235.00 | A | G | CO | W |



A



G



CO







W





LEONARDO TRAY

| CODE |  cm | CHF |  |  |  |  |
|---------|---|--------------|---|---|---|---|
| ASO.010 | 9.6 h. | 3.50 | A | G | CO | W |
| ASO.015 | 13.8 h. | 4.50 | A | G | CO | W |
| ASO.020 | 17.7 h. | 9.50 | A | G | CO | W |
| ASO.030 | 24.9 h. | 13.50 | A | G | CO | W |
| ASO.040 | 33.5 h. | 19.50 | A | G | CO | W |
| ASO.050 | 47.9 h. | 29.00 | A | G | CO | W |
| ASO.075 | 64.5 h. | 49.00 | A | G | CO | W |



A



G



CO



W



GEFÄSSE AUS 100% RECYCLIERTEM MATERIAL

TIZIANO **NEU**

CODE



CHF



ATI.030

30 x 55 h.

85.00

A

G

CO

W



A



G



CO



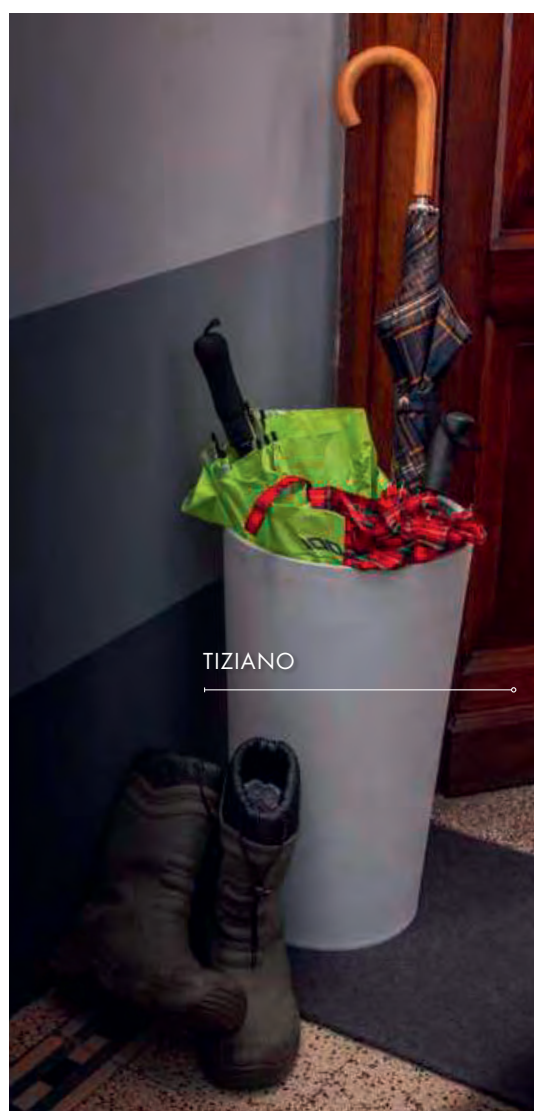

W



GEFÄSSE AUS 100% RECYCLIERTEM MATERIAL



CARAVAGGIO CUBE

| CODE |  |  | CHF |  |
|---------|---|---|--------|---|
| ACU.040 | 40 x 40 x 40 h. | 60 L | 135.00 | A G CO W |

ROLLEN CHF

4 Stk. 20.-



A



G





CO



W



CARAVAGGIO PLANTER

| CODE |  |  | CHF |  |
|---------|--|---|--------|---|
| ACU.080 | 80 x 40 x 40 h. | 120 L | 225.00 | A G CO W |

ROLLEN CHF

4 Stk. 20.-



A



G



CO





W



GEFÄSSE AUS 100% RECYCLIERTEM MATERIAL

MICHELANGELO WINDOW BOX **NEU**

| CODE |  cm |  L | CHF |  |
|---------|--|---|--------------|---|
| ABA.030 | 30 x 11 x 9.3 h. | 2.8 L | 25.00 | A G CO W |
| ABA.050 | 49 x 15 x 16.1 h. | 10 L | 30.00 | A G CO W |
| ABA.060 | 59 x 15.5 x 16.1 h. | 14 L | 35.00 | A G CO W |



A



G





CO



W

MICHELANGELO TRAY

| CODE |  cm | CHF |  |
|---------|---|--------------|--|
| ASB.030 | 30 x 11 h. | 8.00 | A G CO W |
| ASB.050 | 50 x 15 h. | 16.00 | A G CO W |
| ASB.060 | 60 x 16 h. | 21.00 | A G CO W |



A



G



CO







W







MICHELANGELO WINDOW BOX

LIGNUM

| CODE |  cm |  cm |  | CHF |  | | | | | | | | |
|-------------|--|--|---|--------|---|---|---|---|---|----|----|----|----|
| OT-LIGNUM65 | 64 × 43 h. | 57 × 35 h. | 75 L | 179.00 | W | S | R | O | A | GR | BN | GH | GD |
| OT-LIGNUM81 | 81 × 55 h. | 73 × 45 h. | 150 L | 359.00 | W | S | R | O | A | GR | BN | GH | GD |



QUADRIS

| CODE |  |  |  |  | CHF |  | | | | | | | | |
|----------|---|---|---|---|---------------|---|---|---|---|---|----|----|----|----|
| OT-QUA40 | 44 × 44 × 44 h. | 36 × 36 × 36 h. | 45 L | F0529 | 169.00 | W | S | R | O | A | GR | BN | GH | GD |
| OT-QUA60 | 60 × 60 × 60 h. | 47 × 47 × 38 h. | 90 L | F0450 | 379.00 | W | S | R | O | A | GR | BN | GH | GD |



W



S



R



O



A

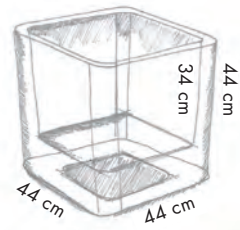

GR



BN



GH



GD

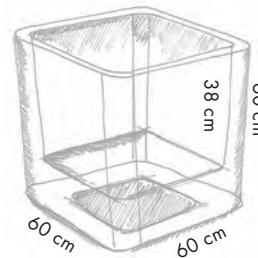

QUADRIS 60 (W)



QUADRIS 40 LONG (W)

QUADRIS 40 LONG

| CODE | | | | CHF | |
|-----------|--------------|--------------|-------|--------|-----------------------|
| OT-QUA40L | 44 × 44 × 90 | 36 × 36 × 80 | 110 L | 389.00 | W S R O A GR BN GH GD |

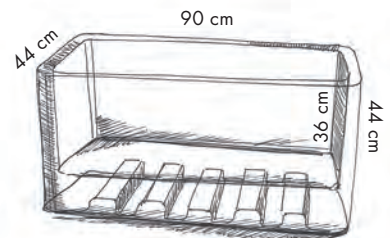
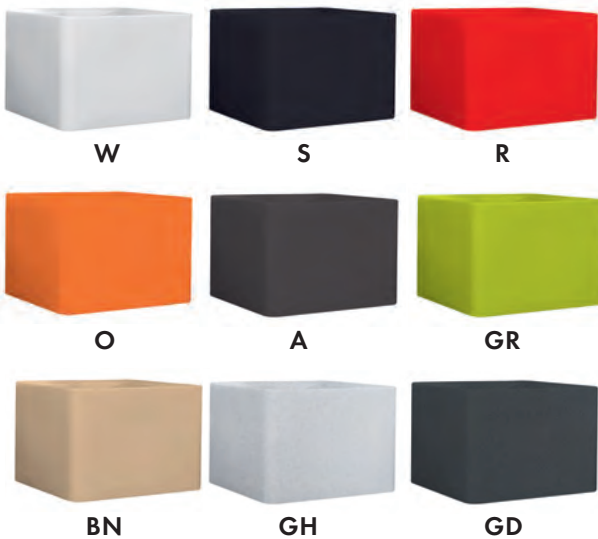

PENDULUM SQUARE

| CODE |  cm | CHF |  | | | | | | |
|----------|--|--------|---|---|---|---|---|----|----|
| OT-PENSQ | 42 × 42 × 39 h. | 149.00 | W | S | R | O | A | GR | BN |

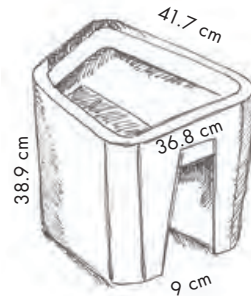

HANGING SYSTEM
FÜR PENDULUM

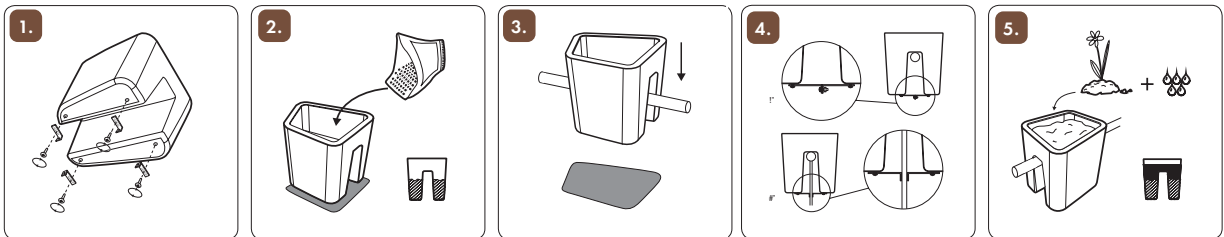



PENDULUM LONG (A)

PENDULUM SQUARE (W)



PENDULUM LONG

| CODE |  | CHF |  | | | | | | |
|------------|---|--------|---|---|---|---|---|----|----|
| OT-PENLONG | 44 × 44 × 39 h. | 289.00 | W | S | R | O | A | GR | BN |

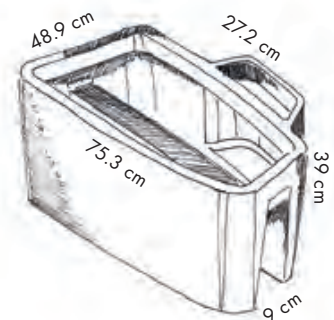
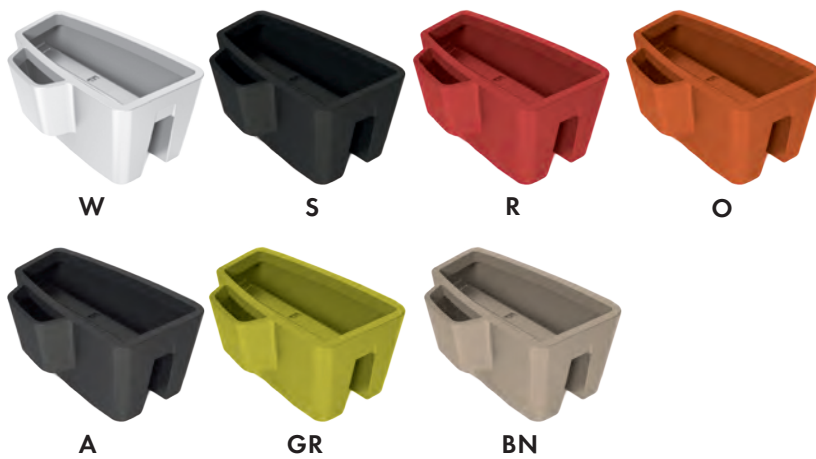

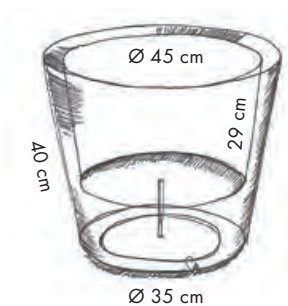

OLLA 40

| | | | | | | |
|----------|---|---|---|---|--------|---|
| CODE |  |  |  |  | CHF |  |
| OT-OLL40 | 47 × 40 h. | 37 × 29 h. | 10 L | F0425 | 149.00 | W S R O A GR BN |



CITTA

| | | | | |
|----------|---|---|---------|---|
| CODE |  |  | CHF |  |
| OT-CITTA | 120 x 110 h. | 690 L | 1100.00 | W S A |

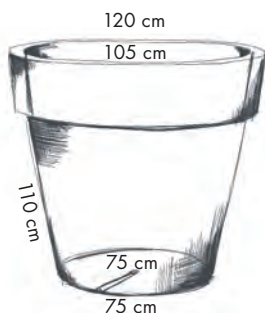

CITTA



MURUS 90 (BN)

MURUS 90

| CODE | | | | CHF | |
|--------|-----------------|-----------------|------|--------|-----------------|
| OT-MUR | 90 × 27 × 80 h. | 85 × 22 × 32 h. | 60 L | 379.00 | W S R O A GR BN |

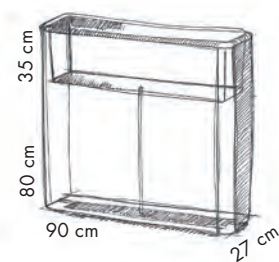
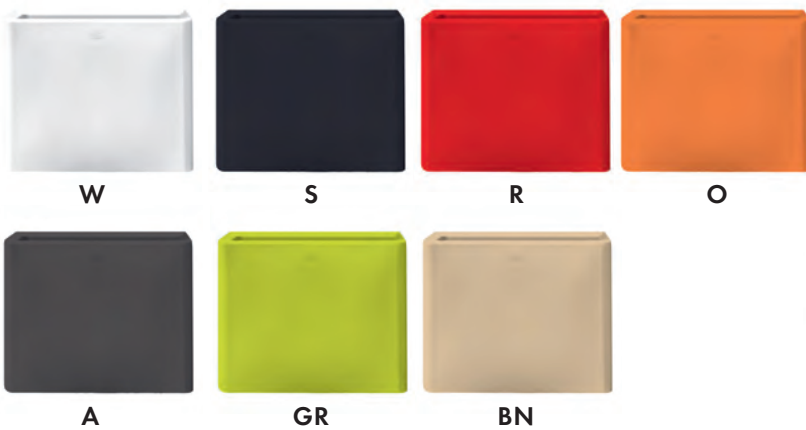

CYLINDRUS FP

| | | | | | | |
|--------|------------|------------|-----|-------|--------|-----------------|
| CODE | | | | | CHF | |
| OT-CYL | 43 × 43 h. | 33 × 32 h. | 9 L | F0430 | 159.00 | W S R O A GR BN |

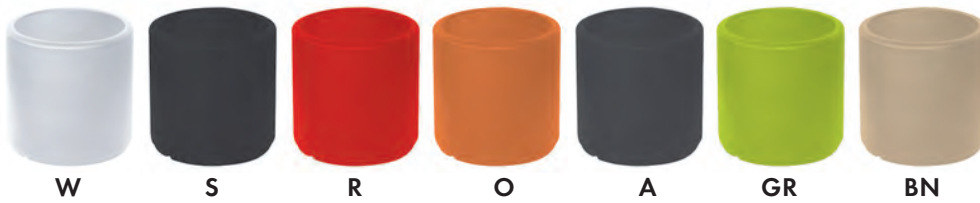



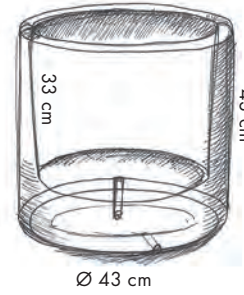

SITZKISSEN CYLINDRUS

| | | | |
|--------|------------|--------|-------|
| CODE | | CHF | |
| OT-CYL | 43 × 43 h. | 159.00 | W S R |



CYLINDRUS FP (S)

LINEA 40

| CODE |  |  |  | CHF |  |
|------------|---|---|---|--------|---|
| OT-LINEA40 | 38 X 38 X 75 h. | 30 X 30 X 32 h. | 28 L | 290.00 | W S A |

ROLLEN CHF





4 Stk. 20.-



A



LINEA 100

| CODE |  |  |  | CHF |  |
|-------------|---|---|---|--------|---|
| OT-LINEA100 | 100 x 38 x 75 h. | 92 x 30 x 32 h. | 88 L | 490.00 | W S A |

ROLLEN CHF

4 Stk. 20.-



A

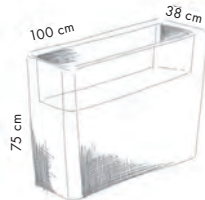

LINEA 100



LINEA 40

BASSO FP

| | | | | | | |
|--------|---|---|---|---|---------------|--|
| CODE |  |  |  |  | CHF |  |
| OT-BAS | 80 × 44 h. | 69 × 27 h. | 350 L | F0450 | 379.00 | W S R O A GR BN |





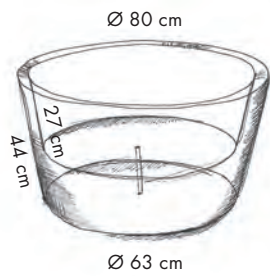

TISCHPLATTE (ZEDERHOLZ) FÜR BASSO FP

| | | | |
|--------|---|---------------|---|
| CODE |  | CHF |  |
| OT-CYL | 80 × 44 h. | 459.00 | Holz |





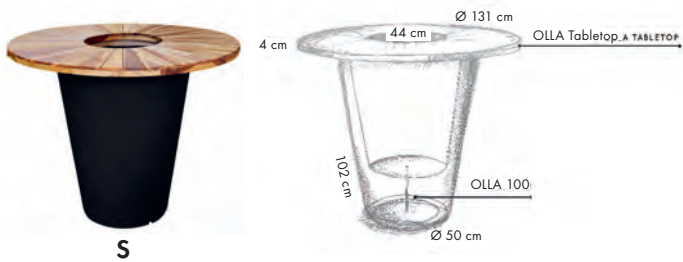

OLLA TABLE HERBA

| | | | | | |
|----------|---|---|---|----------------|---|
| CODE |  |  |  | CHF |  |
| OT-OLLTH | 131 × 102 h. | 64 × 70 h. | 163 L | 1190.00 | S |



OLLA TABLE HERBA

KRONOS ART. R29

| CODE |  cm |  cm |  |  | CHF |  |
|---------|--|--|---|---|---------------|--|
| N R2930 | 30 × 24 h. | 25 × 21 h. | 9.5 L | N R1626 | 21.50 | IM A |
| N R2940 | 40 × 32 h. | 33 × 29 h. | 22.5 L | N R1632 | 42.50 | IM A |
| N R2950 | 50 × 40 h. | 41.5 × 37 h. | 44 L | N R1642 | 75.00 | IM A |
| N R2960 | 60 × 48 h. | 49.5 × 45 h. | 76 L | N R1652 | 115.00 | IM A |
| N R2970 | 70 × 56 h. | 57.5 × 53 h. | 126 L | N R1658 | 159.00 | IM A |



IM



A







KRONOS (IM)



HERA (IM)

HERA ART. R38

| CODE |  cm |  cm |  |  | CHF |  | | | | |
|---------|--|--|---|---|---------------|---|----|---|---|----|
| N R3830 | 30 × 23 h. | 25 × 20 h. | 14 L | N R1630 | 29.00 | W | IM | A | G | HA |
| N R3840 | 40 × 30 h. | 34 × 27 h. | 32 L | N R1642 | 42.00 | W | IM | A | G | HA |
| N R3850 | 50 × 38 h. | 42 × 35 h. | 62 L | N R1648 | 89.00 | W | IM | A | G | HA |
| N R3860 | 60 × 45 h. | 51 × 42 h. | 107 L | N R1652 | 139.00 | W | IM | A | G | HA |



W



IM



A



G



HA

CLIO ART. R51

| CODE |  |  |  | CHF |  |
|---------|---|---|---|-------|---|
| N R5132 | 32 × 18 h. | 28 × 14 h. | 5 L | 22.00 | IM A |







IM



A

THETIS ART. R42

| CODE |  |  |  |  | CHF |  |
|---------|--|--|--|--|-------|--|
| N R4240 | 40 × 16 h. | 36 × 13 h. | 16 L | N R1642 | 32.00 | W IM A G HA |
| N R4250 | 50 × 20 h. | 43 × 17 h. | 20 L | N R1648 | 55.00 | W IM A G HA |
| N R4260 | 60 × 24 h. | 52 × 21 h. | 24 L | N R1658 | 85.00 | W IM A G HA |



W



IM



A



G







HA





ATHENA ART. R40

| CODE |  |  |  | CHF |  |
|---------|---|---|---|-------|--|
| N R4050 | 50 × 29 × 23 h. | 46 × 25 × 20 h. | 22 L | 39.00 | W IM A G HA |





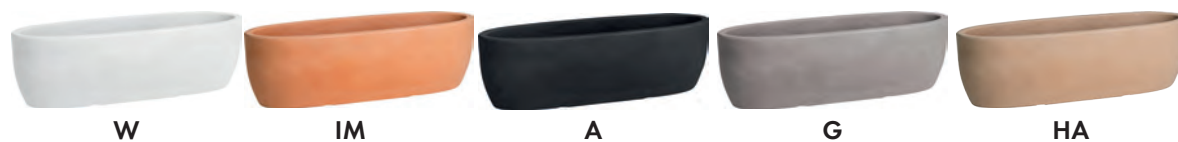

IRIS ART. R52

| CODE |  |  |  | CHF |  |
|---------|---|---|---|-------|--|
| N R5260 | 60 × 20 × 18 h. | 56 × 14 × 15 h. | 15 L | 35.00 | W IM A G HA |



ECHO ART. R55

| CODE |  |  |  |  | CHF |  | | |
|---------|---|---|---|---|--------------|--|---|---|
| N R5535 | 35 × 42 h. | 29 × 24 h. | 13 L | N R1642 | 69.00 | W | A | G |



W







A



G

MYSIA ART. R45

| CODE |  |  |  | CHF |  | | | | |
|---------|---|---|---|--------------|--|----|---|---|----|
| N R4540 | 40 × 20 × 18 h. | 36 × 17 × 15 h. | 10 L | 26.50 | W | IM | A | G | HA |
| N R4550 | 50 × 20 × 18 h. | 46 × 17 × 15 h. | 13 L | 32.50 | W | IM | A | G | HA |



W



IM



A







G



HA

CHIRON ART. R60

| CODE |  |  |  |  | CHF |  | | |
|---------|---|---|---|---|--------------|---|---|---|
| N R6050 | 50 × 29 h. | 42 × 26 h. | 30 L | N R1632 | 45.00 | W | A | G |
| N R6060 | 60 × 36 h. | 51 × 33 h. | 54 L | N R1636 | 75.00 | W | A | G |



W







A



G



MOMUS ART. R41

| CODE |  |  |  | CHF |  |
|---------|---|---|---|---------------|---|
| N R4135 | 35 × 35 × 35 h. | 31 × 31 × 32 h. | 42 L | 79.00 | W A G |
| N R4150 | 50 × 50 × 50 h. | 44 × 44 × 44 h. | 123 L | 169.00 | W A G |



W







A







G

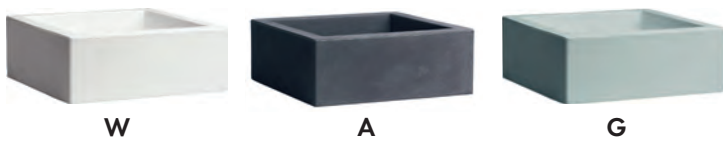



MINOS ART. R44

| CODE |  |  |  | CHF |  |
|---------|---|---|---|---------------|---|
| N R4425 | 25 × 25 × 12 h. | 20.5 × 20.5 × 12 h. | 7 L | 17.50 | W A G |
| N R4440 | 40 × 40 × 15 h. | 33 × 33 × 15 h. | 23 L | 49.00 | W A G |
| N R4460 | 60 × 60 × 22.5 h. | 49.5 × 49.5 × 19.5 h. | 79 L | 110.00 | W A G |

**MINOS CASSETTA** ART. R46



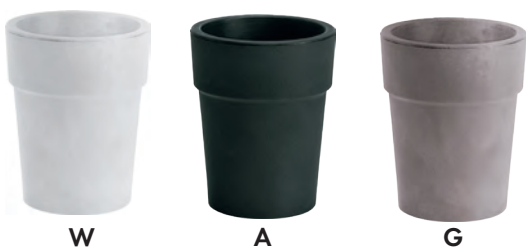

| CODE |  |  |  | CHF |  |
|---------|--|--|--|--------------|---|
| N R4645 | 45 × 20 × 12 h. | 40 × 15 × 11 h. | 8 L | 24.50 | W A G HA |

**ARES** ART. R39

| CODE |  |  |  |  | CHF |  |
|---------|---|---|---|---|--------------|---|
| N R3920 | 20 × 25 h. | 17 × 22 h. | 6 L | | 19.00 | W A G |
| N R3930 | 30 × 37.5 h. | 25.5 × 34.5 h. | 20 L | N R1630 | 35.00 | W A G |
| N R3940 | 40 × 50 h. | 33.5 × 47 h. | 45 L | N R1636 | 75.00 | W A G |



MODUS CASSETTA ART. R61

| CODE |  |  |  |  | CHF |  |
|---------|---|---|---|---|--------|---|
| N R6180 | 80 × 40 × 40 h. | 71 × 31 × 30 h. | 58 L | 2 × F0522 | 199.00 | W A G |



W



A







G



MODUS CASSETTA (A)

QUADRO ELEGANCE 40 **NEU**

| CODE |  |  |  |  | CHF |  |
|---------|---|---|---|---|-------|---|
| N R6940 | 39.5 x 39.5 x 39.5 h. | 31.5 x 31.5 x 31.5 h. | 30 L | | 99.00 | A G HA CO |



A



G







HA



CO

CASSETTA ELEGANCE 80 **NEU**

| CODE |  |  |  |  | CHF |  |
|---------|---|---|---|--|--------|---|
| N R7080 | 79 x 39.5 x 39.5 h. | 71.5 x 31.5 x 31.5 h. | 70 L | | 169.00 | A G HA CO |



A



G







HA



CO

TYLUS ELEGANCE 30 **NEU**

| CODE |  |  |  |  | CHF |  |
|---------|---|---|---|---|-------|---|
| N R6830 | 30 x 40 h. | 25.5 x 37.5 h. | | NR1626 | 39.00 | A G HA CO |



A



G







HA







CO

ZEUSS GLOSS ART. R66

| CODE |  |  |  | CHF |  |
|---------|---|---|---|---------------|--|
| N R6630 | 30 × 26 h. | 26 × 25 h. | 11 L | 24.50 | W FA LM SR V HA G |
| N R6640 | 40 × 35 h. | 34.5 × 34 h. | 27 L | 45.00 | W FA LM SR V HA G |
| N R6650 | 50 × 43.5 h. | 43.5 × 42.5 h. | 51 L | 79.00 | W FA LM SR V HA G |
| N R6660 | 60 × 52 h. | 52 × 51 h. | 90 L | 119.00 | W FA LM SR V HA G |

ZEUS MATT **NEU**

| CODE |  |  |  |  | CHF |  |
|---------|---|---|---|---|---------------|---|
| N R7130 | 30 × 26 h. | 26 × 25 h. | 11 L | NR1626 | 24.50 | A G HA CO |
| N R7140 | 40 × 35 h. | 34.5 × 34 h. | 27 L | NR1632 | 45.00 | A G HA CO |
| N R7150 | 50 × 43.5 h. | 43.5 × 42.5 h. | 51 L | NR1642 | 79.00 | A G HA CO |
| N R7160 | 60 × 52 h. | 52 × 51 h. | 90 L | NR1648 | 119.00 | A G HA CO |





GIARNALDO®

Gefäße für Haus und Garten
Pots for home and garden







NATURE IN A POT

ökologisch aus 100% recyceltem Kork

Otium lanciert eine neue Reihe von Pflanzgefäßen aus exklusiven und nachhaltigen Materialien. Wir machen neue Produkte mit 100% recyceltem Kork. Zum einen brauchen wir gebrauchte Weinkorkzapfen und zum anderen den Rest von natürlichem Kork, aus welchem Korkzapfen gestanzt werden. Ausserdem werden speziell entwickelte Verbindungen gebraucht, um die Pflanzgefäße wie aus Naturton aussehen zu lassen. Die Gefäße werden mit Werkzeugen so verarbeitet, dass feine Linien auf der Oberfläche entstehen. Diese sollen dem Betrachter ein wärmendes Gefühl für die Töpfe geben.





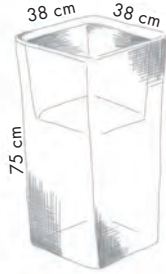

LINEA 40

| CODE |  |  |  | CHF |  |
|-------------|---|---|---|-------|--|
| OT-LINEA40K | 38 X 38 X 75H | 30 X 30 X 32H | 28 L | 325.- | K |

| ROLLEN | CHF |
|--------|------|
| 4 Stk. | 20.- |





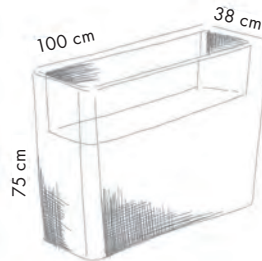

LINEA 100

| CODE |  |  |  | CHF |  |
|--------------|---|---|---|-------|--|
| OT-LINEA100K | 100 X 38 X 75H | 92 X 30 X 32H | 88 L | 550.- | K |

| ROLLEN | CHF |
|--------|------|
| 4 Stk. | 20.- |





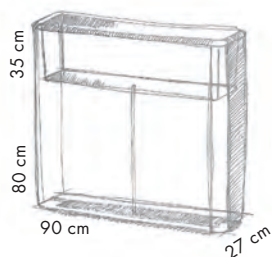

MURUS 90

| CODE |  |  |  | CHF |  |
|--------|---|---|---|-------|--|
| OT-MUR | 90 X 27 X 80H | 85 X 22 X 32H | 60 L | 399.- | K |







LIGNUM

| CODE |  |  |  | CHF |  |
|--------------|---|---|---|-------|--|
| OT-LIGNUM65K | 64 X 43 H | 57 X 35 H | 75 L | 199.- | K |
| OT-LIGNUM81K | 81 X 55 H | 73 X 45 H | 150 L | 389.- | K |





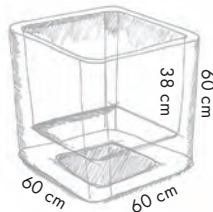
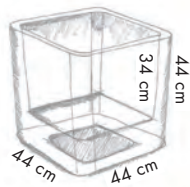

QUADRIS

| CODE |  |  |  | CHF |  |
|--------------|---|---|---|-------|--|
| OT-QUA40K | 44 X 44 X 44H | 34 X 36 X 36H | 43 L | 199.- | K |
| OT-LIGNUM81K | 81 X 55 H | 73 X 45 H | 150 L | 399.- | K |

| ROLLEN | CHF |
|--------|------|
| 4 Stk. | 20.- |



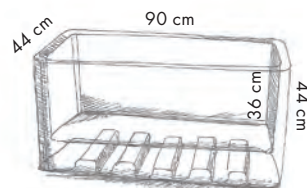

QUADRIS 40 LONG

| CODE |  |  |  | CHF |  |
|------------|---|---|---|-------|--|
| OT-QUA40LK | 44H X 90L X 44W | 34H X 81L X 36W | 106 L | 425.- | K |







AMPHORA

| CODE |  cm |  cm |  | CHF |  |
|------------|--|--|---|-------|--|
| OT-AMPH45K | 35 X 45H | 29 X 30H | 18 L | 149.- | K |
| OT-AMPH75K | 40 X 75H | 33 X 30H | 24 L | 329.- | K |





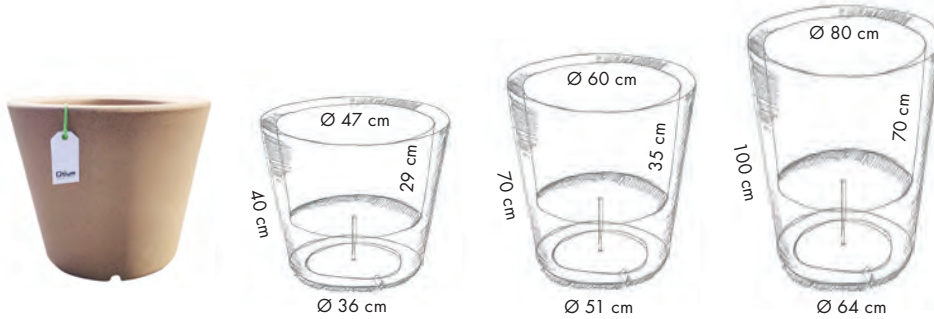

OLLA

| CODE |  cm |  cm |  | CHF |  |
|------------|--|--|---|-------|--|
| OT-OLL40K | 47 X 40H | 36 X 29H | 24 L | 159.- | K |
| OT-OLL70K | 60 X 70H | 51 X 35H | 60 L | 349.- | K |
| OT-OLL100K | 80 X 100H | 64 X 70H | 163 L | 489.- | K |



OLLA TABLE HERBA

| CODE |  cm |  cm |  | CHF |  |
|-----------|--|--|---|--------|--|
| OT-OLLTHK | 131 X 102H | 64 X 70H | 163 L | 1290.- | K |

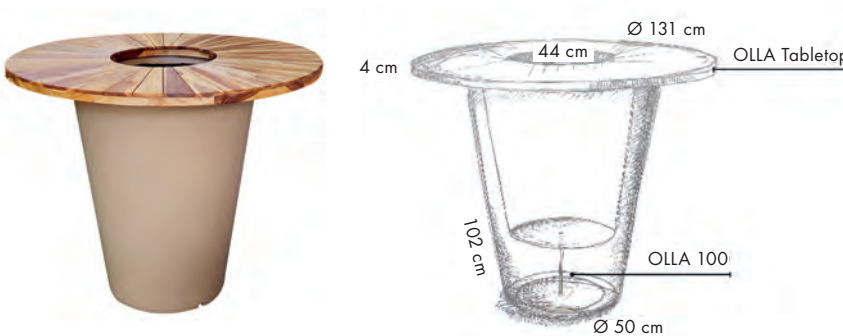

SYMBOLS | SYMBOLES



GRÖSSE/AUSSEN
Länge. Breite. Höhe



GRÖSSE/INNEN
Länge. Breite. Höhe



FARBEN



LITER
(L)



CALYPSO MATT

CALYPSO GLOSS ART. R67

| CODE |  |  |  | CHF |  |
|---------|---|---|---|-------|---|
| N R6750 | 50 × 20 × 18 h. | 44.5 × 14.5 × 15.5 h. | 10 L | 42.00 | W LM SR |



W







LM



SR

CALYPSO MATT NEU

| CODE |  |  |  | CHF |  |
|---------|---|---|---|-------|---|
| N R6250 | 50.3 × 20 × 18.2 h. | 43.3 × 15 × 15.3 h. | 11 L | 42.00 | A G HA W |



A



G







HA







W

LOGOS GLOSS ART. R59

| CODE |  |  |  | CHF |  |
|---------|---|---|---|-------|---|
| N R5930 | 30 × 30 × 43 h. | 24 × 24 × 40 h. | 27 L | 55.00 | W FA LM SR SA BR V |



TALOS GLOSS ART. R58

| CODE |  |  |  | CHF |  |
|---------|--|--|--|--------|---|
| N R5833 | 33 × 70 h. | 27 × 30 h. | 15 L | 110.00 | W FA LM SR SA BR V |
| N R5843 | 43 × 90 h. | 35.5 × 30 h. | 23 L | 165.00 | W FA LM SR |





TYLUS GLOSS ART. R57

| CODE |  |  |  | CHF |  |
|---------|---|---|---|-------|--|
| N R5730 | 30 × 40 h. | 25.5 × 37 h. | 21 L | 39.00 | W FA LM SR SA BR V |







MODULO CUBO MOONLIGHT

| CODE |  | CHF |  |  |
|-------|---|---------------|---|---|
| CUI50 | 50 × 50 × 50 h. | 429.00 | W | ESP |





ESP = Energiesparlampe

**VASO MYMOU MOONLIGHT**

| CODE |  |  | CHF |  |  |
|-------|---|---|---------------|---|---|
| MOI80 | 51 × 80 h. | 20.5 L | 449.00 | W | ESP |
| MOIA5 | 51 × 105 h. | 21.5 L | 539.00 | W | ESP |





ESP = Energiesparlampe

**VASO LULLABY MOONLIGHT**

| CODE |  |  | CHF |  |  |
|-------|---|---|---------------|---|---|
| LUI80 | 30 × 80 h. | 10.5 L | 449.00 | W | ESP |
| LUIA5 | 32 × 105 h. | 13.5 L | 539.00 | W | ESP |





ESP = Energiesparlampe

**VASO MOD'O MOONLIGHT (95 CM)**

| CODE |  |  | CHF |  |  |
|-------|---|---|---------------|---|---|
| MID95 | 26 × 26 × 95 h. | 9.3 L | 389.00 | W | ESP |

ESP = Energiesparlampe





**VASO TONDO ALTO MOONLIGHT**

| CODE |  |  | CHF |  |  |
|-------|---|---|---------------|---|---|
| TAIA0 | 48 × 97 h. | 35.5 L | 499.00 | W | ESP |
| TAIC0 | 59 × 120 h. | 54 L | 669.00 | W | ESP |

ESP = Energiesparlampe







VASO CILINDRO NATURALIA

| CODE |  |  |  |  | CHF |  |
|-------|---|---|---|---|-------|--|
| NCL30 | 29.5 x 29 h. | 26 x 29 h. | 2 L | SNV30 | 35.00 | A G HA IM |
| NCL40 | 40 x 39 h. | 36 x 39 h. | 5 L | SNV40 | 59.00 | A G HA IM |







QUADRO NATURALIA

| CODE |  |  |  |  | CHF |  |
|-------|---|---|---|---|-------|--|
| NQU40 | 40 x 40 x 40 h. | 35 x 35 x 39 h. | 14 L | SNQ40 | 79.00 | A G HA IM |





CASSETTA NATURALIA

| CODE |  |  |  | CHF |  |
|-------|---|---|---|--------|---|
| NCSA0 | 100 x 40 x 40 h. | 96 x 35.5 x 39 h. | 36 L | 189.00 | A G HA IM |



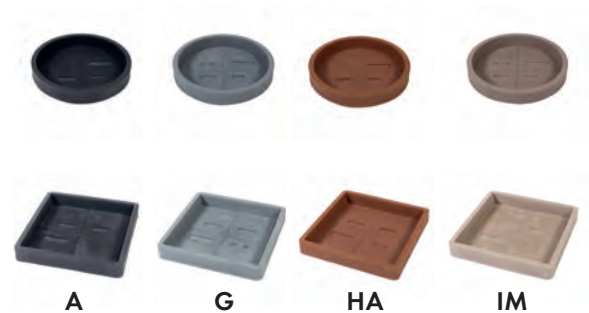

SOTTOVASO NATURALIA

| CODE |  | CHF |  |
|-------|---|-------|---|
| SNV30 | 30 | 12.00 | A G HA IM |
| SNV40 | 40 | 22.00 | A G HA IM |
| SNQ40 | 40 x 40 | 24.00 | A G HA IM |





MYMOOD RAIL

| CODE |  cm |  L | CHF |  |
|----------|--|---|-------|---|
| 71080830 | 29.5 × 22.7 h. | 8 L | 14.50 | DG MW HG V DB |



MYMOOD RAIL LONG

| CODE |  cm |  L | CHF |  |
|----------|---|--|-------|--|
| 71080950 | 48 × 29 × 23 h. | 16.1 L | 27.50 | DG MW HG V DB |







MYMOOD VASO TOWER

| CODE |  |  |  | CHF |  |
|----------|---|---|---|-------------|---|
| 71081336 | 35.5 x 13 h. | 5.9 L | Export 32 | 9.50 | DG MW HG DB |



MYMOOD SCHALE

| CODE |  |  |  | CHF |  |
|----------|---|---|---|-------------|---|
| 71080625 | 24 x 12.7 h. | 4 L | Export 22 | 6.50 | A DG MW HG V HV DB |
| 71080630 | 30 x 15.4 h. | 7.6 L | Export 26 | 9.00 | A DG MW HG V HV DB |





MYMOOD VASO

| CODE |  |  |  | CHF |  |
|----------|---|---|---|--------------|---|
| 71079414 | 13.7 × 11.1 h. | 1 L | Export 12 | 3.00 | A DG MW HG V DB |
| 71079435 | 35 × 29 h. | 15.3 L | Export 24 | 15.00 | A DG MW HG V DB |
| 71079440 | 40 × 34 h. | 24.4 L | Export 28 | 23.50 | A DG MW HG V DB |
| 71079450 | 50 × 41 h. | 43.1 L | Export 34 | 35.00 | A DG MW HG V DB |



UNTERTELLER EXPORT

| CODE |  | CHF |  |
|----------|--|-------------|--|
| 71055524 | 24 × 3.5 h. | 2.50 | A DG MW HG V DB |
| 71055528 | 28 × 3.7 h. | 3.50 | A DG MW HG V DB |
| 71055534 | 34 × 4.4 h. | 6.50 | A DG MW HG V DB |

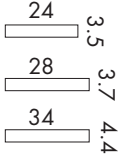
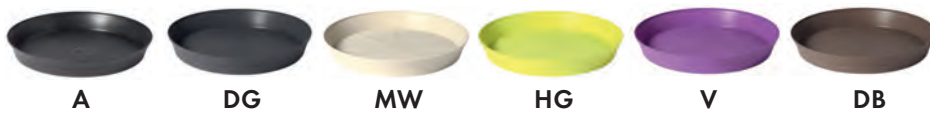





MYMOOD VASO ALTO

| CODE |  |  |  | CHF |  |
|----------|---|---|---|--------------|---|
| 71079745 | 35 × 45 h. | 27.6 L | Export 28 | 29.00 | A DG MW HG V DB |







VASO DOPPIO BORDO FESTONATO

| CODE |  cm |  |  | CHF |  |
|--------|--|---|---|---------------|---|
| DBF40 | 40 × 34 h. | 23 L | SVR23 | 55.00 | IM |
| DBF45 | 44 × 38 h. | 33 L | SVR26 | 65.00 | IM |
| DBF50 | 48 × 42 h. | 43 L | SVR30 | 85.00 | IM |
| DBF55 | 55 × 46 h. | 62 L | SVR33 | 99.00 | IM |
| DBF60 | 60 × 50 h. | 79 L | SVR37 | 115.00 | IM |
| DBF65 | 64 × 53 h. | 93 L | SVR39 | 159.00 | IM |
| DBF75 | 76 × 61 h. | 145 L | SVR45 | 249.00 | IM |
| DBF95 | 96 × 70.5 h. | 265 L | SVR52 | 389.00 | IM |
| DBF111 | 111 × 84 h. | 413 L | SVR66 | 469.00 | IM |



IM

VASO MILO

| CODE |  cm |  |  | CHF |  |
|----------|--|---|---|---------------|---|
| 71063535 | 35 × 30.4 h. | 17 L | SVM23 | 45.00 | A HA |
| 71063542 | 42 × 35 h. | 29 L | SVM27 | 65.00 | A HA |
| 71063548 | 48 × 41 h. | 44 L | SVM29 | 85.00 | A HA |
| 71063558 | 58 × 49 h. | 74 L | SVM34 | 125.00 | A HA |
| 71063568 | 68 × 57 h. | 133 L | SVM45 | 235.00 | A HA |
| 71063588 | 87 × 68 h. | 259 L | SVM58 | 395.00 | A HA |







A

HA



VASO MILO (HA)



VASO LISCIO TOSCANO

| CODE |  cm |  |  | CHF |  |
|--------|--|---|---|--------------|---|
| VLT 35 | 34 × 23 h. | 11.4 L | N R1626 | 26.00 | A |
| VLT 40 | 38 × 27 h. | 16 L | N R1626 | 35.00 | A |
| VLT 45 | 45 × 34 h. | 27 L | N R1630 | 45.00 | A |
| VLT 50 | 50 × 38 h. | 38 L | N R1636 | 63.00 | A |
| VLT 55 | 55 × 41.5 h. | 54 L | N R1642 | 79.00 | A |
| VLT 60 | 61 × 47 h. | 70 L | N R1642 | 89.00 | A |



A

VASO CONCA CORTEN





| CODE |  cm |  | CHF |  |
|----------|--|---|---------------|---|
| 72PCNL30 | 30 × 23 h | 11 L | 29.00 | CO |
| 72PCNL40 | 40 × 31 h | 27 L | 49.00 | CO |
| 72PCNL50 | 50 × 38.5 h | 55.5 L | 95.00 | CO |
| 72PCNL60 | 60 × 46 h | 90 L | 149.00 | CO |



CO





VASO RODI

| CODE |  |  |  | CHF |  | |
|----------|---|---|---|---------------|---|---|
| 71063338 | 34 × 34 × 35 h. | 17 L | incl. | 79.00 | IM | A |
| 71063348 | 48 × 48 × 45 h. | 63 L | incl. | 139.00 | IM | A |





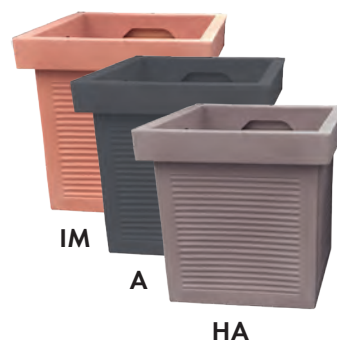

VASO QMR LINGOTTO

| CODE |  |  | CHF |  | | |
|----------|---|---|---------------|---|---|----|
| 72PQMR58 | 57 × 57 × 59 h. | 135 L | 219.00 | IM | A | HA |





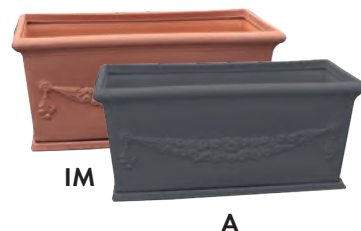

MAXI CASSETTA KEA

| CODE |  |  |  | CHF |  | |
|----------|---|---|---|---------------|---|---|
| 71063170 | 70 × 34 × 29 h. | 49 L | incl. | 129.00 | IM | A |
| 71063190 | 90 × 44 × 40 h. | 130 L | incl. | 229.00 | IM | A |





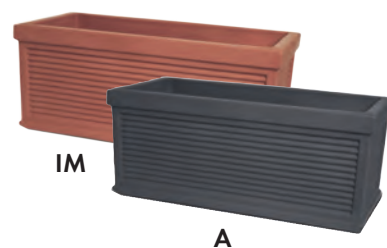

CASSETTA MR

| CODE |  |  |  | CHF |  | |
|----------|---|---|---|---------------|---|---|
| 72PCMR60 | 63 × 28 × 27.5 h. | 33.5 L | SVC 60 | 89.00 | IM | A |
| 72PCMR70 | 73 × 34 × 29.5 h. | 47 L | SVC 70 | 129.00 | IM | A |
| 72PCMR80 | 84 × 41 × 34 h. | 82 L | SVC 80 | 189.00 | IM | A |
| 72PCMR99 | 98 × 41 × 34 h. | 105 L | SVC 100 | 209.00 | IM | A |
| 72PCMRA5 | 104 × 49 × 38.5 h. | 148 L | SVC 105 | 249.00 | IM | A |







VASO TERRANO LISCIO

| CODE |  |  |  | CHF |  |
|--------|---|---|---|---------------|---|
| TBL 40 | 39 × 34 h. | 24 L | N R1630 | 45.00 | IM A HA |
| TBL 45 | 44 × 37.5 h. | 32 L | N R1632 | 55.00 | IM A HA |
| TBL 50 | 51 × 43.5 h. | 47 L | N R1636 | 69.00 | IM A HA |
| TBL 55 | 53 × 46 h. | 57 L | N R1642 | 89.00 | IM A HA |
| TBL 60 | 58 × 49.5 h. | 74 L | N R1648 | 119.00 | IM A HA |
| TBL 70 | 69 × 55.8 h. | 113 L | N R1652 | 219.00 | IM A HA |
| TBL 85 | 84 × 67.5 h. | 210 L | N R1658 | 349.00 | IM A HA |





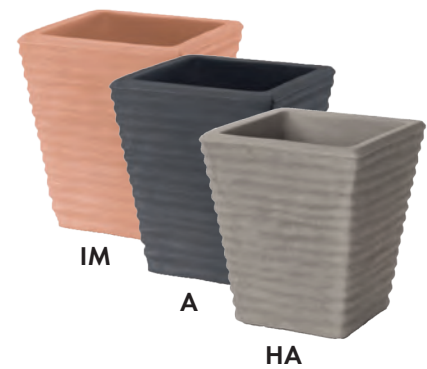

VASO QUADRO RIGATO

| CODE |  |  |  | CHF |  |
|-------|--|--|--|---------------|--|
| VQR30 | 28 × 31 h. | 15.5 L | | 36.00 | IM A HA |
| VQR40 | 38 × 43 h. | 39 L | SVQ40 | 69.00 | IM A HA |
| VQR50 | 50 × 56 h. | 91.3 L | SVQ35 | 159.00 | IM A HA |







CONCA TONDO RIGATO

| CODE |  |  |  | CHF |  |
|-------|---|---|---|--------------|---|
| CTR35 | 33 × 16 h. | 8 L | N R1630 | 26.00 | IM A HA |
| CTR45 | 43 × 19 h. | 17 L | N R1642 | 52.00 | IM A HA |
| CTR55 | 53 × 24 h. | 36 L | N R1652 | 75.00 | IM A HA |







VASO TONDO RIGATO

| CODE |  |  |  | CHF |  |
|-------|---|---|---|---------------|---|
| VTR30 | 31 × 34 h. | 14 L | N R1626 | 45.00 | IM A HA |
| VTR40 | 43 × 45.5 h. | 38 L | N R1632 | 68.00 | IM A HA |
| VTR55 | 55 × 61 h. | 83.5 L | N R1642 | 135.00 | IM A HA |





VASO TONDO LISCIO BORDATO

| CODE |  |  |  | CHF |  |
|-------|---|---|---|---------------|---|
| TLB35 | 34 × 33 h. | 16 L | incl. | 39.00 | W IM A HA |
| TLB40 | 40 × 40 h. | 26.9 L | incl. | 68.00 | W IM A HA |
| TLB50 | 50 × 48 h. | 49.4 L | incl. | 104.00 | W IM A HA |
| TLB60 | 60 × 58 h. | 86.4 L | incl. | 129.00 | W IM A HA |
| TLB70 | 70 × 66 h. | 139.5 L | incl. | 266.00 | W IM A HA |
| TLB90 | 90 × 85 h. | 309 L | incl. | 428.00 | W IM A HA |







VASO TONDO LISCIO BORDATO

| CODE |  |  | CHF |  |
|-------|--|--|-----------------|--|
| TLBD0 | 130 × 124 h. | 400 L | 1'250.00 | W IM A |







VASO QUADRO LISCIO BORDATO

| CODE |  |  |  | CHF |  |
|-------|---|---|---|---------------|---|
| QLB30 | 29 × 29 × 40 h. | 15.5 L | incl. | 45.00 | IM A HA |
| QLB35 | 34 × 34 × 48 h. | 28.4 L | incl. | 79.00 | IM A HA |
| QLB40 | 38 × 38 × 54 h. | 41.1 L | incl. | 116.00 | IM A HA |
| QLB45 | 44 × 44 × 59 h. | 57.5 L | incl. | 169.00 | IM A HA |







CASSETTA OVALE LISCIA

| CODE |  |  |  | CHF |  |
|-------|---|---|---|--------------|---|
| COL40 | 40 × 22 × 14 h. | 6.3 L | SVO40 | 29.00 | IM A HA |
| COL50 | 55 × 27 × 19 h. | 17.2 L | SVO55 | 45.00 | IM A HA |







CASSETTA LISCIA

| CODE |  |  |  | CHF |  |
|-------|---|---|---|--------|---|
| CLS80 | 79 × 41 × 33.6 h. | 82.7 L | SCL80 | 155.00 | IM A HA CO |
| CLSA0 | 97 × 41 × 33.5 h. | 103.1 L | SCLA0 | 175.00 | IM A HA CO |
| CLSA5 | 103 × 47 × 41 h. | 157 L | SVCA5 | 215.00 | IM A HA CO |





VASO QUADRO LISCO

| CODE |  |  |  | CHF |  |
|-------|---|---|---|--------|---|
| QLS40 | 40 × 40 × 33.5 h. | 38.6 L | SVQ40 | 79.00 | IM A HA CO |
| QLS55 | 55 × 55 × 47 h. | 103 L | SVQ45 | 199.00 | IM A HA CO |



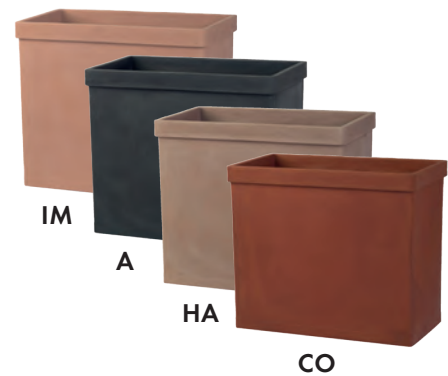

CASSETTA ALTA 62 (EINWANDIG)

| CODE |  |  | CHF |  |
|----------|---|---|--------|---|
| 72PCLA62 | 70 × 35 × 62 h. | 112.5 L | 249.00 | IM A HA CO |





CASSETTA ALTA 62 (A)

VASO MODULO 40 (DOPPELWANDIG)

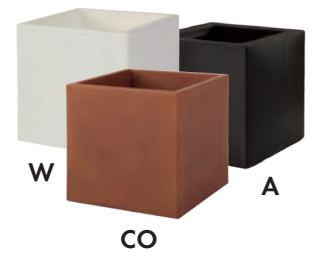
| CODE |  |  | CHF |  |
|----------|---|---|--------|--|
| 72PVMN40 | 40 × 40 × 40 h. | 35 × 35 × 30 h. | 33.5 L | 149.00 |
| | *Pflanztiefe aussen | *Pflanztiefe innen | | W A G CO |





VASO MODULO 50

| CODE |  |  | CHF |  |
|-------|---|---|---------------|---|
| VMN50 | 50 × 50 × 50 (36*) h. | 47 L | 189.00 | W B A O R |
| | *Pflanztiefe innen | | | GR HA |
| | | Rollset | 28.00 | |



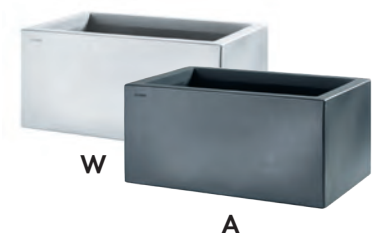

CASSETTA MODULO

| CODE |  |  | CHF |  |
|-------|---|---|---------------|---|
| MCN80 | 80 × 50 × 40 (34.5*) h. | 85 L | 324.00 | W A |
| | *Pflanztiefe innen | | | |
| | | Rollset | 28.00 | |



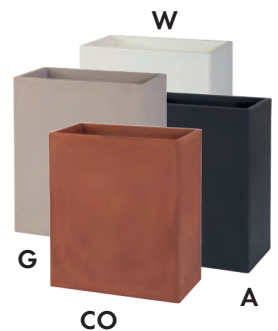

CASSETTA ALTA MODULO 80 (DOPPELWANDIG)

| CODE |  |  | CHF |  |
|----------|---|---|--------|--|
| 72PMCA80 | 65 × 35 × 80 h. | 60 × 35 × 30 h. | 49.6 L | 349.00 |
| | *Pflanztiefe aussen | *Pflanztiefe innen | | W A G CO |





CASSETTA ALTA MODULO 80

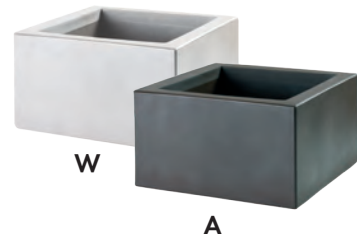

VASO MODULO (NIEDER)

| CODE |  |  | CHF |  |
|--------------------|---|---|---------------|---|
| VMN30 | 50 × 50 × 30 (26*) h. | 35 L | 145.00 | W A |
| *Pflanztiefe innen | | | | |
| Rollset | | | 28.00 | |

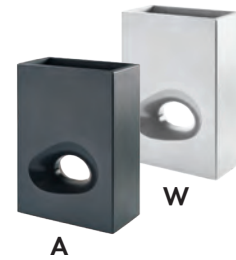

**VASO MOD'O (75 CM)**

| CODE |  |  | CHF |  |
|--------------------|---|---|---------------|---|
| MOD75 | 50 × 26 × 75 (26.5*) h. | 18.5 L | 205.00 | W A |
| *Pflanztiefe innen | | | | |

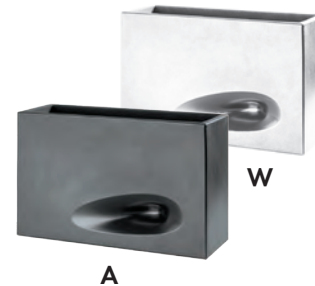

**CASSETTA MOD'O (50 CM)**

| CODE |  |  | CHF |  |
|--------------------|---|---|---------------|---|
| MOD50 | 75 × 26 × 50 (32.5*) h. | 38 L | 215.00 | W A |
| *Pflanztiefe innen | | | | |

**VASO MOD'O (95 CM)**



| CODE |  |  | CHF |  |
|--------------------|---|---|---------------|---|
| MOD95 | 26 × 26 × 95 (27.5*) h. | 9 L | 159.00 | W A |
| *Pflanztiefe innen | | | | |

**VASO CONICO**

| CODE |  |  | CHF |  |
|--------------------|---|---|---------------|---|
| VCN40 | 40 × 40 (26*) h. | 16.2 L | 85.00 | W B A |
| VCN50 | 50 × 50 (35*) h. | 33.5 L | 139.00 | W B A |
| VCN60 | 60 × 60 (41.5*) h. | 51 L | 199.00 | W B A |
| *Pflanztiefe innen | | | | |





VASO TONDO ALTO (70 CM & 100 CM & 120 CM)

| CODE |  |  | CHF |  |
|-------|---|---|---------------|---|
| TAN70 | 34 × 70 (21*) h. | 14 L | 135.00 | W A HA |
| TAN50 | 48 × 97 (36*) h. | 35.5 L | 199.00 | W A HA |
| TANCO | 59 × 120 (41*) h. | 54 L | 359.00 | W A HA |

*Pflanztiefe innen







VASO QUADRO ALTO (70 CM & 100 CM & 120 CM)

| CODE |  |  | CHF |  |
|-------|---|---|---------------|---|
| QUN70 | 34 × 34 × 70 (23*) h. | 14.5 L | 145.00 | W A HA |
| QUNAO | 38 × 38 × 100 (25.5*) h. | 20.2 L | 225.00 | W A HA |
| QUNCO | 45 × 45 × 120 (29*) h. | 33 L | 359.00 | W A HA |

*Pflanztiefe innen



TOSCANO LISCIO





| CODE |  |  |  | CHF |  |
|-------|---|---|---|-------|---|
| *1044 | 44 × 31 h. | 25 L | 5018 | 79.00 | IM |

*Verfügbarkeit nur auf Anfrage



IM

CONICO LISCIO

| CODE |  |  |  | CHF |  | |
|------|---|---|---|--------|---|----|
| *175 | 40 × 32 h. | 20 L | 5007 | 49.00 | A | WE |
| *170 | 44 × 40 h. | 30 L | 5018 | 59.00 | G | WE |
| *171 | 50 × 45 h. | 45 L | 5001 | 75.00 | A | WE |
| *172 | 76 × 62 h. | 160 L | 5028 | 225.00 | G | IM |





*Verfügbarkeit nur auf Anfrage



G

WE

DOPPIO BORDO DERUTA





| CODE |  |  |  | CHF |  |
|------|---|---|---|--------|---|
| *443 | 115 × 78 h. | 350 L | 5006 | 499.00 | G |

*Verfügbarkeit nur auf Anfrage



G

CAMPANA CLASSICA





| CODE |  |  |  | CHF |  |
|------|---|---|---|-------|---|
| *160 | 50 × 38 h. | 38 L | 5018 | 99.00 | IM |

*Verfügbarkeit nur auf Anfrage



IM

CASSETTA AGRIFOGLIO





| CODE |  |  |  | CHF |  |
|-------|---|---|---|-------|---|
| *1580 | 81 × 40 × 33 h. | 37 L | 5030 | 99.00 | IM |

*Verfügbarkeit nur auf Anfrage



IM

CASSETTA MILLERIGHE ITALIANO





| CODE |  |  |  | CHF |  |
|------|---|---|---|---------------|---|
| *101 | 57 × 25 × 24 h. | 25 L | 5100 | 99.00 | IM |
| *103 | 87 × 39 × 34 h. | 82 L | 5103 | 189.00 | IM |

*Verfügbarkeit nur auf Anfrage



IM

CASSETTA FESTONATO FIORI





| CODE |  |  |  | CHF |  |
|------|---|---|---|---------------|---|
| *090 | 58 × 26 × 24 h. | 25 L | 5100 | 99.00 | IM |
| *091 | 77 × 33 × 31 h. | 56 L | 5102 | 169.00 | IM |

*Verfügbarkeit nur auf Anfrage



IM

CASSETTA BIANCOSPINO





| CODE |  |  |  | CHF |  |
|--------|---|---|---|---------------|---|
| *14100 | 101 × 45 × 40 h. | 145 L | 5104 | 199.00 | IM |

*Verfügbarkeit nur auf Anfrage



IM

BALCONETTA MILLERIGHE ITALIANO



| CODE |  |  |  | CHF |  |
|------|---|---|---|--------------|---|
| *120 | 59 × 18 × 16 h. | 11 L | 5107 | 69.00 | IM |
| *121 | 69 × 20 × 17 h. | 15 L | 5105 | 89.00 | IM |

*Verfügbarkeit nur auf Anfrage



IM

CAMELIA

| CODE |  |  | CHF |  | |
|-------|---|---|---------------|---|------|
| *1355 | 35 × 35 × 55 h. | 25 L | 149.00 | IM | WE |
| *1373 | 46 × 46 × 74 h. | 62 L | 229.00 | IM | A WE |
| *1390 | 55 × 55 × 91 h. | 135 L | 259.00 | IM | A WE |

*Verfügbarkeit nur auf Anfrage







IM

A

WE

TULIPANO

| CODE |  |  |  | CHF |  |
|-------|---|---|---|--------|---|
| *1290 | 90 × 93 h. | 265 L | 5004 | 419.00 | IM A |



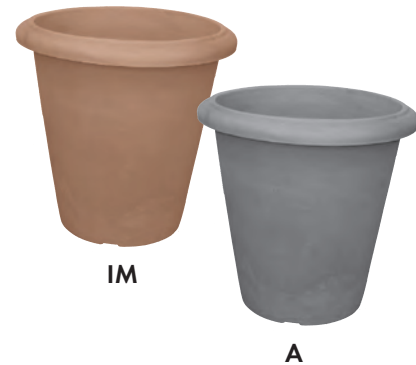

*Verfügbarkeit nur auf Anfrage



IM

A

QUADRATO ALLORO

| CODE |  |  |  | CHF |  |
|-------|---|---|---|--------|---|
| *3838 | 38 × 38 × 62 h. | 56 L | 5201 | 179.00 | IM A |



*Verfügbarkeit nur auf Anfrage



IM

A

QUADRATO BIANCOSPINO

| CODE |  |  |  | CHF |  |
|-------|---|---|---|-------|---|
| *1445 | 45 × 45 × 40 h. | 37 L | 5202 | 99.00 | IM A |



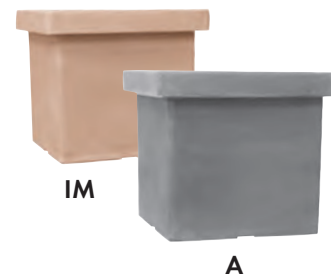

*Verfügbarkeit nur auf Anfrage



IM

A

ROSONE

| CODE |  |  |  | CHF |  |
|------|---|---|---|-------|---|
| *085 | 38 × 38 × 35 h. | 34 L | 5201 | 99.00 | IM A |



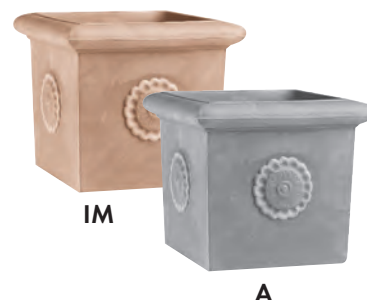

*Verfügbarkeit nur auf Anfrage



IM

A

MILLERIGHE ITALIANO QUADRATO





| CODE |  |  |  | CHF |  |
|------|---|---|---|-------|---|
| *180 | 36 × 36 h. | 25 L | 5200 | 89.00 | IM |
| *181 | 41 × 34 h. | 42 L | 5201 | 99.00 | IM |

*Verfügbarkeit nur auf Anfrage



IM

MILLERIGHE ITALIANO QUADRATO ALTO





| CODE |  |  |  | CHF |  |
|------|---|---|---|--------|---|
| *187 | 43 × 43 × 51 h. | 75 L | 5203 | 189.00 | IM |

*Verfügbarkeit nur auf Anfrage



IM

MILLERIGHE ITALIANO RETTANGOLARE ALTO



| CODE |  |  |  | CHF |  |
|------|---|---|---|--------|---|
| *188 | 43 × 26 × 52 h. | 39 L | 5101 | 159.00 | IM |

*Verfügbarkeit nur auf Anfrage



IM

FESTONATO FRUTTI ANGOLARE





| CODE |  |  | CHF |  |
|-------|---|---|--------|---|
| *3025 | 48 × 48 × 57 h. | 84 L | 199.00 | IM |

*Verfügbarkeit nur auf Anfrage



IM

MILLERIGHE ITALIANO ANGOLARE





| CODE |  |  |  | CHF |  |
|------|---|---|---|--------|---|
| *185 | 33 × 50 h. | 39 L | 5220 | 129.00 | IM |

*Verfügbarkeit nur auf Anfrage



IM

GRECATI



| CODE |  |  |  | CHF |  |
|------|---|---|---|--------|---|
| *071 | 60 × 60 × 45 h. | 90 L | 5203 | 149.00 | IM |

*Verfügbarkeit nur auf Anfrage



IM

CONCA LIGURE



| CODE |  |  | CHF |  |
|-------|---|---|--------|---|
| *7100 | 88 × 30 h. | 48 L | 159.00 | IM |

*Verfügbarkeit nur auf Anfrage



IM

MILLERIGHE MAGNUM QUADRATO



| CODE |  |  | CHF |  |
|------|---|---|--------|---|
| *470 | 45 × 45 × 41 h. | 77 L | 139.00 | A |

*Verfügbarkeit nur auf Anfrage



A

MANHATTAN (60 CM)

| CODE |  |  | CHF |  |
|--------|---|---|--------|---|
| *MS 02 | 40 × 60 h. | 40 L | 169.00 | IM A GE O R WE GL |

*Verfügbarkeit nur auf Anfrage



IM

A

GE



O

R

WE

GL

MANHATTAN (90 CM)

| CODE |  |  | CHF |  |
|--------|---|---|--------|---|
| *MS 01 | 40 × 90 h. | 60 L | 239.00 | IM A GE O WE GL |

*Verfügbarkeit nur auf Anfrage



IM

A



GE

O

WE

GL



GINZA (55 CM)

| CODE |  |  | CHF |  |
|--------|---|---|---------------|---|
| *MS 09 | 40 × 40 × 55 h. | 52 L | 169.00 | IM A GE O R WE GL |

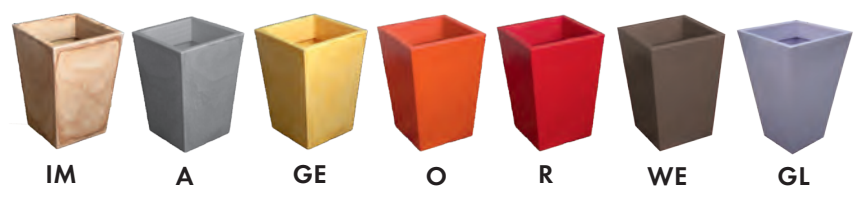
*Verfügbarkeit nur auf Anfrage



GINZA (90 CM)

| CODE |  |  | CHF |  |
|--------|---|---|---------------|---|
| *MS 10 | 45 × 45 × 90 h. | 103 L | 279.00 | IM GE O R GL |

*Verfügbarkeit nur auf Anfrage

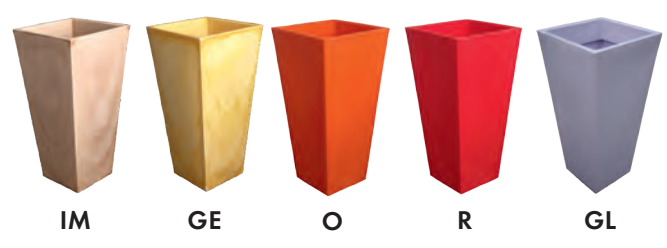

ATLAS UNTERTELLER RUND ART. R16

| CODE | | | CHF | | | | | | | | |
|---------|---------------|---------------|-------|----|---|---|----|------|-----|--|----|
| N R1626 | 26 × 3.5 h. | 22 × 3 h. | 12.00 | IM | A | G | HA | 26 | 3.5 | | IM |
| N R1630 | 30 × 3.7 h. | 25.5 × 3.2 h. | 14.00 | IM | A | G | HA | 30 | 3.7 | | A |
| N R1632 | 32.5 × 3.9 h. | 27 × 3.4 h. | 15.00 | IM | A | G | HA | 32.5 | 3.9 | | G |
| N R1636 | 36.5 × 4.2 h. | 30 × 3.7 h. | 18.00 | IM | A | G | HA | 36.5 | 4.2 | | HA |
| N R1642 | 42.5 × 5 h. | 36 × 4.5 h. | 25.00 | IM | A | G | HA | 42.5 | 5 | | |
| N R1648 | 48.5 × 5.3 h. | 42 × 4.8 h. | 29.00 | IM | A | G | HA | 48.5 | 5.3 | | |
| N R1652 | 52.5 × 5.3 h. | 46 × 4.8 h. | 33.00 | IM | A | G | HA | 52.5 | 5.3 | | |
| N R1658 | 58.5 × 5.8 h. | 51 × 5.3 h. | 42.00 | IM | A | G | HA | 58.5 | 5.8 | | |

PASSEND FÜR | COMBINABLE AVEC



THEMIS SOTTOCASSETTA QUADRO ART. R35

| CODE | | | CHF | | | | | | | | |
|---------|------------------|----------------|-------|----|---|---|----|----|-----|--|----|
| N R3540 | 39 × 39 × 4.5 h. | 35 × 35 × 4 h. | 32.00 | IM | A | G | HA | 39 | 4.5 | | IM |
| | | | | | | | | | | | A |
| | | | | | | | | | | | G |
| | | | | | | | | | | | HA |

THEMIS SOTTOCASSETTA ART. R34

| CODE | | | CHF | |
|---------|--------------------|--------------------|--------------|--------|
| N R3460 | 60.5 × 30.5 × 4 h. | 56.5 × 26.5 × 4 h. | 39.00 | IM A G |
| N R3480 | 79 × 39 × 4.5 h. | 75 × 35 × 4.5 h. | 52.00 | IM A G |
| N R3499 | 99 × 39 × 4.5 h. | 95 × 35 × 4.5 h. | 69.00 | IM A G |

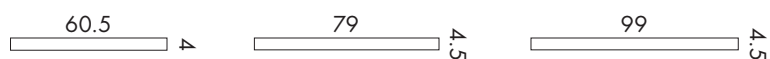

ZUBEHÖR | ACCESSOIRES

CARRELLO ROTONDO SILVER ART. F04

| CODE | | | | CHF | |
|---------|-------------|-------------|----|--------------|----|
| N F0425 | 27 × 6.5 h. | 25 × 6.5 h. | 70 | 28.00 | SL |
| N F0430 | 32 × 6.5 h. | 30 × 6.5 h. | 70 | 30.00 | SL |
| N F0435 | 37 × 7 h. | 35 × 7 h. | 70 | 33.00 | SL |
| N F0440 | 42 × 7 h. | 40 × 7 h. | 70 | 36.00 | SL |
| N F0450 | 52 × 7.5 h. | 50 × 7.5 h. | 70 | 40.00 | SL |





CARRELLO QUADRATO SILVER ART. F05

| CODE | | | | CHF | |
|---------|------------------|------------------|----|--------------|----|
| N F0522 | 27 × 27 × 6.5 h. | 23 × 23 × 6.5 h. | 70 | 28.00 | SL |
| N F0529 | 33 × 33 × 6.5 h. | 29 × 29 × 6.5 h. | 70 | 30.00 | SL |
| N F0533 | 37 × 37 × 6.5 h. | 33 × 33 × 6.5 h. | 70 | 33.00 | SL |



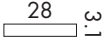
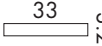
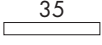
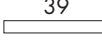
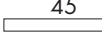
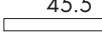
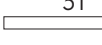
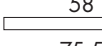
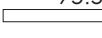

UNTERTELLER SVR

| CODE |  |  | CHF |  | |
|-------|---|---|-------|---|---|
| SVR23 | 28.0 × 3.1 h. | 23.0 × 2.9 h. | 12.00 | IM |  |
| SVR26 | 33.0 × 3.2 h. | 26.5 × 2.8 h. | 16.00 | IM |  |
| SVR30 | 35.0 × 3.5 h. | 29.0 × 3.2 h. | 18.00 | IM |  |
| SVR33 | 39.0 × 3.1 h. | 32.5 × 3.0 h. | 19.00 | IM |  |
| SVR37 | 45.0 × 3.4 h. | 37.0 × 2.9 h. | 21.00 | IM |  |
| SVR39 | 45.5 × 3.7 h. | 38.0 × 3.2 h. | 22.00 | IM |  |
| SVR45 | 51.0 × 3.2 h. | 44.0 × 3.2 h. | 35.00 | IM |  |
| SVR52 | 58.0 × 3.4 h. | 52.0 × 3.1 h. | 37.00 | IM |  |
| SVR66 | 75.5 × 4.5 h. | 65.0 × 4.0 h. | 38.00 | IM |  |



IM

UNTERTELLER SVM

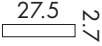
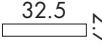
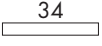
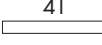
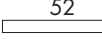
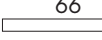
| CODE |  |  | CHF |  | | |
|-------|---|---|-------|---|----|--|
| SVM23 | 27.5 × 2.7 h. | 23.0 × 2.4 h. | 12.00 | A | HA |  |
| SVM27 | 32.5 × 2.7 h. | 27.0 × 2.7 h. | 16.00 | A | HA |  |
| SVM29 | 34.0 × 3.1 h. | 29.0 × 3.0 h. | 18.00 | A | HA |  |
| SVM34 | 41.0 × 3.1 h. | 34.0 × 3.0 h. | 21.00 | A | HA |  |
| SVM45 | 52.0 × 3.2 h. | 45.0 × 3.2 h. | 35.00 | A | HA |  |
| SVM58 | 66.0 × 3.2 h. | 58.0 × 3.2 h. | 37.00 | A | HA |  |





A



HA



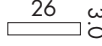
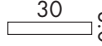

UNTERTELLER RUND

| CODE |  |  | CHF |  | |
|-------|---|---|------|---|---|
| SVT21 | 26.0 × 3.0 h. | 20.0 × 2.7 h. | 5.90 | A |  |
| SVT25 | 30.0 × 3.0 h. | 23.0 × 2.8 h. | 7.90 | A |  |
| SVT35 | 35.0 | | 9.90 | A | |





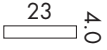

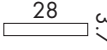
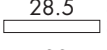
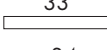
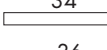
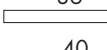
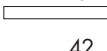
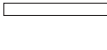
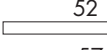
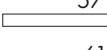
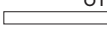

A

UNTERTELLER RUND

| CODE |  |  | CHF |  | | | |
|-------|---|---|--------------|---|---|--|---|
| *5024 | 23.0 × 4.0 h. | 19.0 × 3.3 h. | 19.00 | IM | A |  |  |
| *5014 | 28.0 × 3.7 h. | 22.0 × 3.2 h. | 19.00 | IM | |  | |
| *5007 | 28.5 × 3.5 h. | 23.0 × 3.1 h. | 20.00 | IM | A |  | |
| *5017 | 33.0 × 3.4 h. | 29.0 × 3.1 h. | 20.00 | IM | A |  | |
| *5018 | 34.0 × 4.0 h. | 29.5 × 3.0 h. | 20.00 | IM | A |  | |
| *5001 | 36.0 × 3.4 h. | 32.0 × 3.0 h. | 22.00 | IM | A |  | |
| *5020 | 40.0 × 4.0 h. | 34.5 × 3.2 h. | 22.00 | IM | |  | |
| *5013 | 42.0 × 3.9 h. | 36.5 × 3.2 h. | 23.00 | IM | |  | |
| *5012 | | 38.0 | 26.00 | IM | | | |
| *5009 | | 41.0 | 27.00 | IM | | | |
| *5028 | 52.0 × 3.7 h. | 45.5 × 3.3 h. | 35.00 | IM | |  | |
| *5029 | 57.0 × 3.8 h. | 51.0 × 3.1 h. | 36.00 | IM | |  | |
| *5006 | 61.0 × 4.2 h. | 56.5 × 3.4 h. | 39.00 | | A |  | |

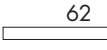
*Verfügbarkeit nur auf Anfrage

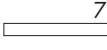
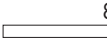
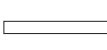
UNTERTELLER RECHTECKIG (FÜR CMR)

| CODE |  | CHF |  | | | |
|--------|---|--------------|---|---|---|---|
| SVC60 | 62 × 27 | 35.00 | IM | A |  |  |
| SVC70 | 71 × 33 | 55.00 | IM | A |  | |
| SVC80 | 88 × 44 | 85.00 | IM | A |  | |
| SVC100 | 97 × 40 | 75.00 | IM | A |  | |
| SVC105 | 102 × 48 | 95.00 | IM | A |  | |

UNTERTELLER RECHTECKIG

| CODE | | | CHF | | | | | | |
|--------|----------------|-------------------|-------|---|----|-----|-----|--|----|
| *SCL80 | 77 × 39 × 4.4 | 72 × 34.5 × 3.6 | 59.00 | A | HA | 77 | 4.4 | | A |
| *SCLA0 | 96 × 39 × 4.4 | 91.5 × 34.5 × 3.5 | 69.00 | A | HA | 96 | 4.4 | | HA |
| *SCLA5 | 104 × 49 × 5.2 | 95 × 41 × 4.8 | 99.00 | A | HA | 104 | 5.2 | | |

*Verfügbarkeit nur auf Anfrage

UNTERTELLER RECHTECKIG



| CODE | | | CHF | | | | | | |
|-------|-----------------|-----------------|-------|----|---|-----|-----|--|----|
| *5100 | 59 × 26.5 × 3.8 | 54 × 21.5 × 3.3 | 25.00 | IM | | 59 | 3.8 | | IM |
| *5101 | 53 × 27 × 4.2 | 48.5 × 23 × 3.1 | 25.00 | IM | A | 53 | 4.2 | | A |
| *5102 | 80 × 39 × 3.7 | 75 × 35 × 3.3 | 45.00 | IM | | 80 | 3.7 | | |
| *5103 | 90 × 44 × 3.6 | 85 × 37.5 × 3.1 | 55.00 | IM | A | 90 | 3.6 | | |
| *5104 | 99 × 46.5 × 3.6 | 94 × 42 × 3.2 | 65.00 | IM | A | 99 | 3.6 | | |
| *5105 | 75 × 25 × 4.2 | 70 × 20 × 3.3 | 22.00 | IM | | 75 | 4.2 | | |
| *5106 | 71 × 33 × 3.9 | 65.5 × 29 × 3.3 | 35.00 | IM | | 71 | 3.9 | | |
| *5107 | 64 × 22.5 × 3.9 | 60 × 20 × 2.8 | 27.00 | IM | A | 64 | 3.9 | | |
| *5108 | 63 × 32 × 4.0 | 58 × 28 × 3.1 | 33.00 | IM | | 63 | 4.0 | | |
| *5109 | 82 × 28 × 3.8 | 77.5 × 24 × 3.0 | 49.00 | IM | | 82 | 3.8 | | |
| *5110 | 92 × 29 × 4.1 | 87 × 23.5 × 3.0 | 50.00 | IM | | 92 | 4.1 | | |
| *5111 | 103 × 29 × 4.0 | 98 × 24 × 3.2 | 52.00 | IM | | 103 | 4.0 | | |
| *5114 | 49 × 31 × 4.1 | 44 × 26 × 3.1 | 27.00 | IM | | 49 | 4.1 | | |

*Verfügbarkeit nur auf Anfrage

UNTERTELLER QUADRATISCH

| CODE | | | CHF | | | | | | |
|--------|---------------|---------------|-------|---|----|----|-----|--|----|
| SVQ 35 | 39 × 39 × 4.1 | 35 × 35 × 3.7 | 35.00 | A | HA | 39 | 4.1 | | A |
| SVQ 40 | 45 × 45 × 5.2 | 38 × 38 × 4.9 | 39.00 | A | HA | 45 | 5.2 | | HA |
| SVQ 45 | 54 × 54 × 5.0 | 45 × 45 × 4.7 | 59.00 | A | HA | 54 | 5.0 | | |

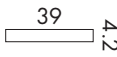
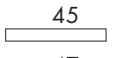
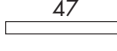

UNTERTELLER QUADRATISCH

| CODE |  |  | CHF |  | |
|-------|---|---|-------|---|--|
| *5201 | 39 × 39 × 4.2 | 35 × 35 × 3.4 | 32.00 | IM |  |
| *5202 | 45 × 45 × 4.1 | 39 × 39 × 3.3 | 39.00 | IM |  |
| *5203 | 47 × 47 × 4.0 | 41 × 41 × 3.2 | 39.00 | IM |  |

*Verfügbarkeit nur auf Anfrage



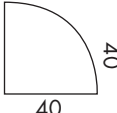

UNTERTELLER SAGOMATO

| CODE |  |  | CHF |  | |
|-------|---|---|-------|---|---|
| *5220 | 40 × 40 × 4.1 | 36 × 36 × 3.3 | 39.00 | IM |  |

*Verfügbarkeit nur auf Anfrage

UNTERTELLER OVAL

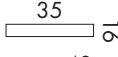
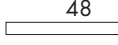
| CODE |  |  | CHF |  | |
|--------|---|---|-------|---|---|
| SVO 40 | 35 × 16 | COL40 | 17.50 | IM |  |
| SVO 55 | 48 × 21 | COL55 | 29.50 | IM |  |



FARBEN & SYMBOLE



FARBEN | COULEURS

| | | | |
|--|---------------------|-------------------------|-----------------------------|
| A ANTHRAZIT | G GRAU | SL SILBER | SW SAND WEISS |
| A ANTHRAZIT (VERSCH. HERSTELLER) | GR GRÜN | SA SAFRAN | MW MARMOR WEISS |
| B BORDEAUX | HA HAVANNA | SR SCHARLACH ROT | LK LED KALT |
| BN BRAUN | HG HELL GRÜN | T TERRACOTTA | LW LED WARM |
| BR BRONZE | IM IMPRUNETA | V VIOLETT | MC LED MULTICOLOR |
| DB DUNKEL BEIGE | LM LIME | HV HELLVIOLETT | ESP ENERGIESPARLAMPE |
| DG DUNKEL GRAU | M MOKKA | WE WENGE | CO CORTEN |
| F FUCHSIA | O ORANGE | W WEISS | |
| FA FANGO | R ROT | GW GRANIT WEISS | |
| GE GELB | RO ROST | GH GRANIT HELL | |
| GL GLYCINE | S SCHWARZ | GD GRANIT DUNKEL | |

LICHT | LUMIÈRE

SYMBOLE | SYMBOLES

| | | |
|---|---|--|
| GRÖSSE/AUSSEN Länge. Breite. Höhe | UNTERTELLER Code/Nr. | UNTERTELLER Grösse Aussen |
| GRÖSSE/INNEN Länge. Breite. Höhe | UNTERTELLER AUF ROLLEN Code/Nr. | UNTERTELLER Grösse Innen (Volumen) |
| LITER (L) | UMFANG | UNTERTELLER RUND/ECKIG Grösse Umfang |
| FARBEN | KILOGRAMM/KG | UNTERTELLER AUF ROLLEN Grösse Umfang |
| LICHT | | |



Gefässe für Haus und Garten
Pots for home and garden

info@giarnaldo.ch
www.giarnaldo.ch

Giarnaldo GmbH
CH-4513 Langendorf

Tel. +41 (0)32 623 54 80